

Product Catalog



Vinyl Siding • Evolve Stone • Accessories • and MORE



Our warehouse is your warehouse

DELIVERY OPTIONS

Scheduled Days:	Mon & Wed	Tues & Thurs	Friday	No Scheduled Days
Customer	CT MA RI	NH NY VT	Flex Day	ME NJ
Order Deadlines:	For Monday: • Thursday 12pm For Wednesday: • Monday 12pm	For Tuesday: • Friday 12pm For Thursday: • Tuesday 12pm	For Friday: • Wednesday 4pm	Delivery from a 3rd party freight carrier would deliver within 1 week from date of order (<i>if material is in stock</i>)
Freight Cost:	None	Freight could be included if you: <ul style="list-style-type: none"> • Had less than \$20K in previous year purchases • Are over 100 miles from Fairway's warehouse • Order is less than \$3k • Are a non-partner <i>Fairway will provide a quote for delivery</i>	Fridays will be reserved as a "Flex Day" to allow us the flexibility to deliver where needed, ensuring we can accommodate any additional or urgent requests.	<ul style="list-style-type: none"> • Minimum order amount of \$3K • No shipping of incomplete orders <i>Fairway will provide a quote for delivery</i>

Keep in Mind

- We still offer a drive-thru option if you need something sooner.
⇒ *Call for details - Cut-off time for pickup is 3pm*
- On occasion, Fairway may inquire if an order could be delivered on your next scheduled day.
- On occasion, Fairway may inquire if an order could be delivered earlier than your next scheduled day.
- On occasion, a delivery may be delayed due to extreme weather, traffic, employee health/safety, vehicle malfunction, or other extenuating circumstances.
⇒ In these instances, Fairway will communicate delivery timing as soon as possible.
- Please note: during non-peak months (November - March), Fairway Wholesale's dispatch team may implement a winter delivery schedule because of customer order slowdown and/or adverse winter weather/driving conditions. This may reduce your regular scheduled days to a single day on occasion.



FAIRWAY WHOLESALE DISTRIBUTION, LLC

654 New Ludlow Rd, South Hadley, MA 01075

800.729.3247

Fax 888.432.4792

Orders@FairwayWholesale.net

FAIRWAY CATALOG rev: 5.2024

IMPORTANT INFORMATION

Delivery Options 2

Return & Restocking Policy..... 4,5

SIDING

SIDING CONT.

Align Composite Cladding 37
 Cedar Creek 29
 Colorguard 28
 Concord 6,7
 Fairway 28
 Harbor Ridge RUSTIC..... 32
 Highland 17
 Metalunic Moderno 36
 Northern Star Board & Batten 31
 Oregon Pride 16
 Pleasant View Skirting..... 33
 Sentry 18,19
 Sentry Board & Batten 20,21
 Sentry Variegated..... 22
 Sequoia Select 10,11
 Sequoia Select Board & Batten..... 12,13
 Signature Supreme..... 8,9
 Single 8..... 33

Waterford 30
 West Ridge 24,25

SHINGLE & STONE

ABTCO 7" Perfection Shingle 49
 Cape Cod Shingle..... 46
 DuraKwik Stone 42,43
 Evolve Stone 39,40,41
 Fairhaven Sound 44,45
 Foundry 7" Perfection Shingle 48
 Grayne 5" & 7.5" Cedar Shingle 47
 Round Shape 32

Custom Displays..... 63
 Notes..... 38

ACCESSORIES

20' Corners 53
 ABTCO Soffit..... 34
 ABTCO Accessories..... 35
 Aluminum Coil 59
 Bay Window Corners..... 55
 Blocks & Vents 50
 Block & Vent Colors..... 51
 Brakes..... 61
 Caulk..... 60
 Dark Roast Vinyl Trim..... 23
 Door Surround 56
 Fascia 60
 Gentek Soffit..... 14

Gentek Accessories 15
 Housewrap..... 58
 Insulation..... 58
 Mitten Soffit 26
 Mitten Accessories..... 27
 Nails 60
 PVC Post Wraps..... 57
 PVC Accessories 57
 Shutters..... 52
 Tools 62
 Window Casing 53
 Window & Door Headers 54
 Window & Door Lineals..... 55

Business Hours: Monday to Friday 7:30am - 4:00pm
Address: 654 New Ludlow Rd, South Hadley, MA 01075
Phone: 800.729.3247 413.532.7703
Fax: 888.432.4792 413.534.7556

www.FairwayWholesale.com

Prices subject to change without notice.

See pages 4 & 5 for additional information.



MATERIAL RETURN POLICY

- Request for return must be faxed or emailed. It must indicate what material and amount to be returned and include original P.O.# or invoice # material was purchased from. NO MATERIAL WILL BE PICKED UP WITHOUT PRIOR WRITTEN REQUEST.
- In some circumstances Fairway may require pictures of material to determine if an RMA will be generated.
- Provide Fairway a contact name so our driver can ask for them if your yard employee cannot find the material.
- Do not request material return until items are physically in your yard.
- RMA will be closed after 2 unsuccessful attempts to pickup.
- If you have more than 1 location, please specify which location material will be picked up from.
- All return merchandise and boxes must be clean and undamaged. No credit will be issued for material which is unsuitable to place back in stock for immediate re-sale. Please do not return anything that you would not accept on your next order.
- Product will be inspected at time of pickup and also once returned to Fairway Warehouse. If OK at that point, credit will be issued.
- Individually boxed material such as: Gable vents, Pilasters, Window Headers, Shutters, etc., must be returned in original/undamaged box with hardware included.
- SPECIAL ORDER materials are NOT RETURNABLE.
- Aluminum coil, aluminum starter strip, 20ft Fluted & Traditional corners, Evolve Stone & Accessories, 3.5" & 5" Lineal, 20ft Quarter rounds, Flex J, Brakes & Tools ARE NOT RETURNABLE.
- Material must be identified as originally being purchased from Fairway.
- **Returns must be requested within 60 days of original purchase.**
- Returns will be picked up at Fairways convenience and when truck space permits.
- Material purchased as discontinued or final sale are not returnable.
- Cash, check or credit card sales—NO CREDIT will be given without original receipt. Credit will be given in form of payment made (for example: if paid with credit card, credit will be given to credit card).

Notes:

Deviation from any of the above conditions is cause to refuse items for credit.

All counts by Fairway are final.

Material refused by Fairway will be discarded immediately if not removed by customer.

Material returned on Fairway truck which is unacceptable for credit will be scrapped.



RESTOCKING FEE POLICY

No Restocking Fee for returned items that meet the following:

1. Clean, undamaged and unopened/full boxes only.
2. Product will be inspected upon return before credit is issued.
3. See Material Return Policy Page
4. Request must be made within 60 days of product invoice. If not, 10% restocking fee will be applied.
5. Customer brings return material to Fairway.

COLOR SWATCHES

Colors in this catalog may vary slightly from actual product colors. We recommend making final color selection using product samples.

NON-STOCK / SPECIAL ORDERS

Any special order item or color not listed, please call Fairway for pricing, surcharges, and delivery fees.

PALLET FEE

For large siding orders you may request the siding be put on our pallets when shipping. There will be a \$200 per pallet fee. If pallets are returned to Fairway in good condition a credit will be issued. It is up to you to notify Fairway when pallets are ready for pickup.

.042"

CONCORD D4"

SIDING - TRADITIONAL COLORS

Stock D4" Colors



Special Order Colors

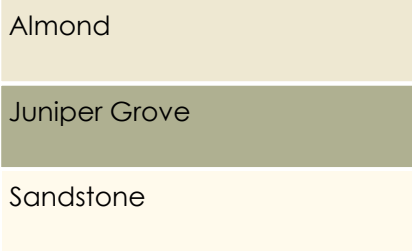

DOUBLE 4

LIGHT ROUGHSAWN TEXTURE

Matching Shake Colors: Pg 44

Matching Block Colors: Pg 51

Item	Size	Pcs/Ctn
Concord D4	12' 6"	24 - 2 sq
3/4" J Channel	12'	40
3.5" Outside Corner Post	10'	10
Inside Corner	10'	10
Undersill Trim	12'	40



Rolled Nail Hem

Special Order Profiles



DOUBLE 4 DUTCHLAP



DOUBLE 5 DUTCHLAP



DOUBLE 5

CONCORD D4''

1.042"

Stock D4'' Colors



DOUBLE 4

LIGHT ROUGHSAWN TEXTURE

Matching Shake Colors: Pg 45
Matching Block Colors: Pg 51

Item - Premium Colors	Size	Pcs/Ctn
Concord D4	12' 6"	24 - 2 sq
3/4" J Channel	12'	40
3.5" Outside Corner Post	10'	10
Inside Corner	10'	10
Undersill Trim	12'	40



Rolled Nail Hem

Other Special Order Profiles



DOUBLE 4
DUTCHLAP



DOUBLE 5
DUTCHLAP



DOUBLE 5

SIDING - PREMIUM COLORS

.044"

SIGNATURE SUPREME D4™

SIDING - TRADITIONAL COLORS

Stock D4" Colors

Dover Gray

Pearl

Pebble

Sage

Snow White



Special Order Colors

Almond

Canyon Clay

Juniper Grove

Linen

Maize

Monterey Sand

Sandstone

Wicker



DOUBLE 4

HARDWOOD TEXTURE

Matching Shake Colors: Pg 44

Matching Block Colors: Pg 51

Item	Size	Pcs/Ctn
Signature Supreme D4	12' 6"	24 - 2 sq
3/4" J Channel	12'	40
3.5" Outside Corner Post	10'	10
Inside Corner	10'	10
Undersill Trim	12'	40



PowerLok Infrastructure Technology

Special Order Profiles



DOUBLE 4
DUTCHLAP



DOUBLE 5
CLAPBOARD



DOUBLE 5
DUTCHLAP

SIGNATURE SUPREME D4™

0.44"

Stock D4™ Colors

Chesapeake Gray
Harbor Bay
Hudson Slate
Meadow Fern
Midnight Surf
Storm
Windswept Smoke



DOUBLE 4

HARDWOOD TEXTURE

Matching Shake Colors: Pg 45
 Matching Block Colors: Pg 51

Special Order Colors

Dark Drift
Majestic Brick
Moonlit Moss
Rockport Brown

Item - Premium Colors	Size	Pcs/Ctn
Signature Supreme D4	12' 6"	24 - 2 sq
3/4" J Channel	12'	40
3.5" Outside Corner Post	10'	10
Inside Corner	10'	10
Undersill Trim	12'	40



**PowerLok
 Infrastructure
 Technology**

Special Order Profiles



DOUBLE 4
DUTCHLAP



DOUBLE 5
CLAPBOARD



DOUBLE 5
DUTCHLAP

SIDING - PREMIUM COLORS

.046"

SEQUOIA SELECT D4"

Special Order Colors

- Almond
- Canyon Clay
- Dover Gray
- Juniper Grove
- Linen
- Maize
- Monterey Sand
- Pearl
- Pebble
- Sage
- Sandstone
- Snow White
- Wicker



DOUBLE 4

CEDAR GRAIN

Matching Shake Colors: Pg 44
Matching Block Colors: Pg 51

SIDING - TRADITIONAL COLORS

Item - Traditional Colors	Size	Pcs/Ctn
Sequoia Select D4	12' 6"	24 - 2 sq
3/4" J Channel	12'	40
3.5" Outside Corner Post	10'	10
Inside Corner	10'	10
Undersill Trim	12'	40

PREMIER DESIGN AND CONSTRUCTION

Extra-Heavy Wall Thickness Heavy-duty .046" thickness provides superior rigidity, ensuring straight, smooth walls.

Full-Roll Nailing Hem Delivers double-strength wall attachment.

Exclusive Advantage Lock™ System Securely connects panels, greatly enhancing rigidity and stability.

Hurricane-Velocity Wind Resistance Built hurricane-tough! In laboratory tests simulating hurricane-force wind conditions, Sequoia Select withstood windloads up to 253 mph.*

Rich Cedargrain Emboss Beautiful low-gloss finish achieves natural appeal and excellent durability; requires minimal upkeep.

Superior Lap Height Full 3/4" lap height creates a deeper dimension and enhanced shadow lines for a true wood look.

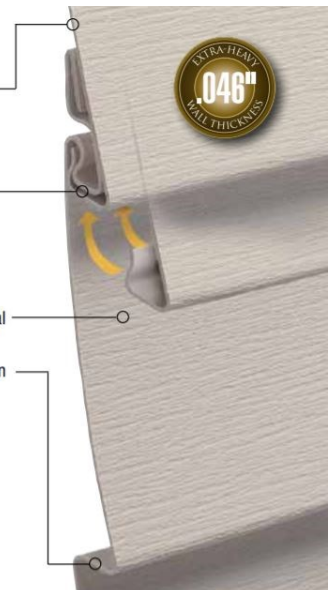

Special Order Profiles

- Double 4-1/2" Dutch Lap
- Double 5" Clapboard
- Double 5" Dutch Lap
- 7" Vertical Board and Batten

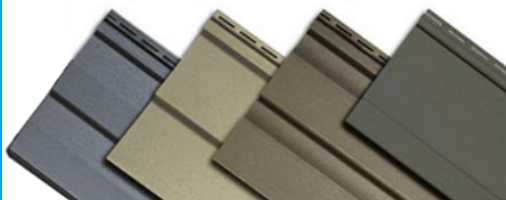

SEQUOIA SELECT D4™

.046"

Stock D4™ Colors

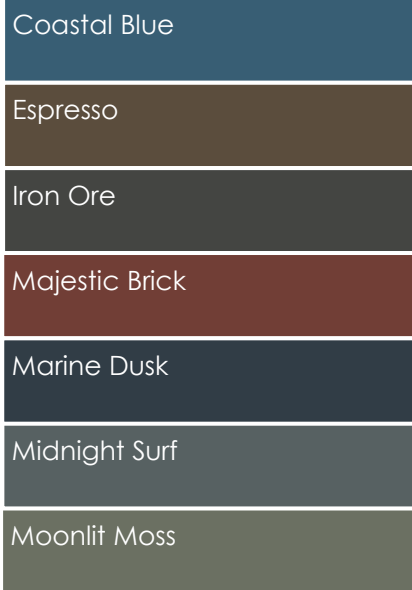

DOUBLE 4

CEDAR GRAIN

Matching Shake Colors: Pg 45
Matching Block Colors: Pg 51

Special Order Colors



Item - Premium Colors

Item - Premium Colors	Size	Pcs/Ctn
Sequoia Select D4	12' 6"	24 - 2 sq
3/4" J Channel	12'	40
3.5" Outside Corner Post	10'	10
Inside Corner	10'	10
Undersill Trim	12'	40

PREMIER DESIGN AND CONSTRUCTION

Extra-Heavy Wall Thickness Heavy-duty .046" thickness provides superior rigidity, ensuring straight, smooth walls.

Full-Roll Nailing Hem Delivers double-strength wall attachment.

Exclusive Advantage Lock™ System Securely connects panels, greatly enhancing rigidity and stability.

Hurricane-Velocity Wind Resistance Built hurricane-tough! In laboratory tests simulating hurricane-force wind conditions, Sequoia Select withstood windloads up to 253 mph.*

Rich Cedargrain Emboss Beautiful low-gloss finish achieves natural appeal and excellent durability; requires minimal upkeep.

Superior Lap Height Full 3/4" lap height creates a deeper dimension and enhanced shadow lines for a true wood look.

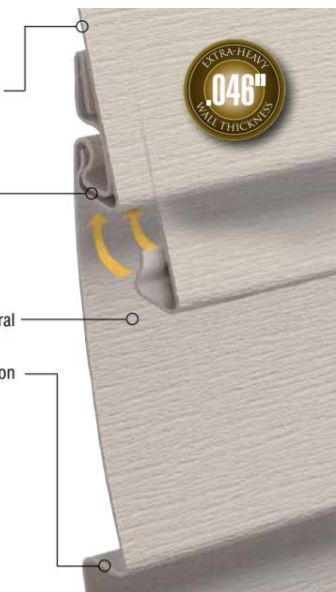

Special Order Profiles

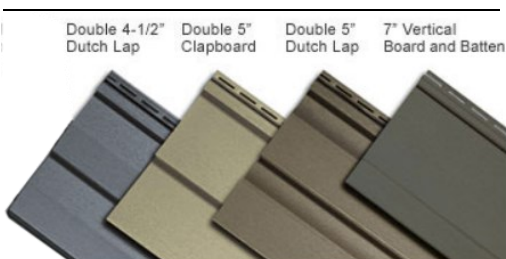

.048"

SEQUOIA SELECT BOARD & BATTEN

Stock Color

Snow White

Special Order Colors

Almond

Canyon Clay

Dover Gray

Juniper Grove

Linen

Maize

Monterey Sand

Pearl

Pebble

Sage

Sandstone

Wicker



LIGHT ROUGHSAWN TEXTURE

Matching Shake Colors: Pg 44

Matching Block Colors: Pg 51

SIDING - TRADITIONAL COLORS

Item - Traditional Colors	Size	Pcs/Ctn
Sequoia Select B&B 7"	10'	17 - 1 sq
3/4" J Channel	12'	40
3.5" Outside Corner	10'	10
Undersill Trim	12'	40



7" Vertical Board & Batten

- Never needs to be painted
- Easy upkeep
- Durable and dent-resistant
- Valuable investment
- Lifetime limited warranty

SEQUOIA SELECT BOARD & BATTEN

048"

Stock Colors

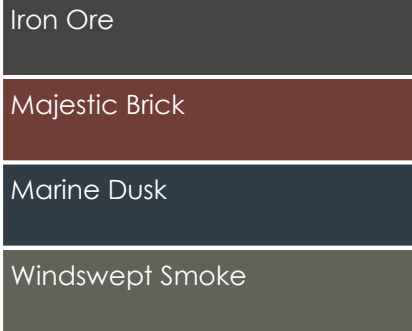

Special Order Colors



LIGHT ROUGHSAWN TEXTURE

Matching Shake Colors: Pg 45
 Matching Block Colors: Pg 51

SIDING - PREMIUM COLORS

Item - Premium Colors	Size	Pcs/Ctn
Sequoia Select B&B 7"	10'	17 - 1 sq
3/4" J Channel	12'	40
3.5" Outside Corner	10'	10
Undersill Trim	12'	40



7" Vertical Board & Batten

- Never needs to be painted
- Easy upkeep
- Durable and dent-resistant
- Valuable investment
- Lifetime limited warranty

SOFFIT - GENTEK

8" Beaded Soffit Stock: Solid, Vented

Snow White Only

Fairweather Stock: Solid, Center Vented* & Fully Vented T4"

Snow White Only

Fairweather T4" Special Order Colors

Almond

Canyon Clay

Chesapeake Gray

Dover Gray

Juniper Grove

Linen

Maize

Monterey Sand

Musket Brown - Soffit Use Only

Pearl

Pebble

Sage

Sandstone

Storm

Wicker



Solid, Center Vented & Fully Vented Soffit .040 - Brushed Texture

Item	Size	Pcs/Ctn
T4" Solid	12' x 12" Brushed	16-2 sq
T4" Center Vent - Lanced	12' x 12" Brushed	16-2 sq
T4" Full Vent - Lanced	12' x 12" Brushed	16-2 sq
8" Solid Beaded	8" x 12' x 6" Matte	12-1 sq
8" Vented Beaded	8" x 12' x 6" Matte	12-1 sq

Fairweather Solid Soffit can also be used as vertical siding
*Fairweather Center Vent Lanced soffit - Snow White only



12" T-4 Solid Soffit/
Vertical Siding



12" T-4
Center Vented



12" T-4
Fully Vented



8" Beaded
Solid

8" Beaded
Vented

SOFFIT

ACCESSORIES - GENTEK

Stock Color

Snow White Only

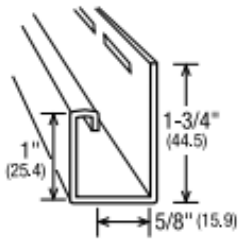

Item	Size	Pcs/Ctn
5/8" J-Channel	12' Brushed	40

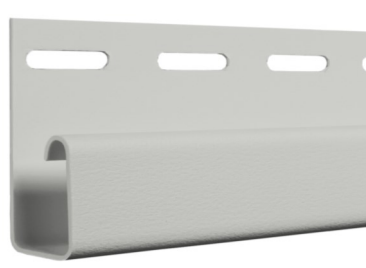
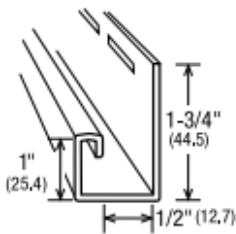

Item	Size	Pcs/Ctn
1/2" J-Channel	12' Brushed	40

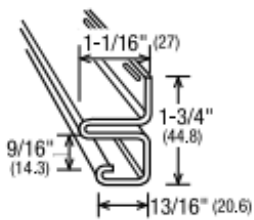

Item	Size	Pcs/Ctn
5/8" F-Channel	12' Brushed	24

ACCESSORIES - TRADITIONAL COLORS

.040"

OREGON PRIDE D4"

SIDING - TRADITIONAL COLORS

Stock D4" Colors



Special Order Colors



DOUBLE 4

WOODGRAIN

Matching Shake Colors: Pg 48
Matching Block Colors: Pg 51

Item	Size	Pcs/Ctn
Oregon Pride D4"	12' 6"	24 - 2 sq
5/8" J Channel	12'	40
3" Outside Corner	10'	12
Undersill Trim	12'	40
Inside Corner	10'	20
Aluminum Starter	10'	50

Performance Features

- COLOUR MATCHED ACCESSORIES
- ROLL-OVER NAIL HEM
- CLASSIC .040" THICKNESS
- LOW GLOSS COLOUR-RICH FINISH
- HURRICANE FORCE WIND SPEED RATED
- LIFETIME COLOUR FADE PROTECTION
- CONTOURED LOCK SYSTEM
- LIMITED LIFETIME WARRANTY

Special Order Profiles



DOUBLE 4 DUTCHLAP



DOUBLE 4.5 DUTCHLAP



HIGHLAND T3''

.040''

Stock Colors

White (Frost)

Special Order Colors

Ash

Bone

Brownstone

Cypress

Flagstone

Hearthstone

Indigo

Nickel

Saffron

Sage

Sandcastle

Satin Grey

Stratus



TRIPLE 3

WOODGRAIN

Matching Shake Colors: Pg 48

Matching Block Colors: Pg 51

Item	Size	Pcs/Ctn
Highland T3''	12'	20 - 2 sq
5/8" J Channel	12'	40
3" Outside Corner	10'	12
Undersill Trim	12'	40
Inside Corner	10'	20
Aluminum Starter	10'	50

Performance Features

 COLOUR MATCHED ACCESSORIES	 ROLL-OVER NAIL HEM
 .040 THICK CLASSIC .040" THICKNESS	 LOW GLOSS LOW GLOSS COLOUR-RICH FINISH
 HURRICANE FORCE WIND SPEED RATED	 LIFETIME COLOUR FADE PROTECTION
 CONTOURED LOCK SYSTEM	 LIMITED LIFETIME WARRANTY

Special Order Profiles (.042" Thickness)



DOUBLE 4

DOUBLE 4.5 DUTCHLAP

DOUBLE 4.5

DOUBLE 5

DOUBLE 5 DUTCHLAP



SIDING - TRADITIONAL COLORS

.044"

SIDING - TRADITIONAL COLORS

SENTRY D4"

Stock D4" Colors

- Bone
- Brownstone
- Cypress
- Flagstone
- Hearthstone
- Indigo
- Nickel
- Saffron
- Sage
- Satin Grey
- Stratus
- White (Frost)

Special Order Colors

- Ash
- Sandcastle



DOUBLE 4

WOODGRAIN

Matching Shake Colors: Pg 48
Matching Block Colors: Pg 51

Item	Size	Pcs/Ctn
Sentry D4"	12' 6"	24 - 2 sq
5/8" J Channel	12'	40
3" Outside Corner	10'	12
Undersill Trim	12'	40
Inside Corner	10'	20
Aluminum Starter	10'	50

Performance Features

-  COLOUR MATCHED ACCESSORIES
-  ROLL-OVER NAIL HEM
-  **.044 THICK** PREMIUM .044" THICKNESS
-  **LOW GLOSS** LOW GLOSS COLOUR-RICH FINISH
-  HURRICANE FORCE WIND SPEED RATED
-  LIFETIME COLOUR FADE PROTECTION
-  CONTOURED LOCK SYSTEM
-  LIMITED LIFETIME WARRANTY

Special Order Profile



DOUBLE 4.5 DUTCHLAP



SENTRY D4"

.044"

Stock D4" Colors

Annapolis Blue
Coffee Bean
Grenadier Green
Gunmetal Grey
Huron Blue
Khaki Brown
Muskoka Green
Regatta Blue
Richmond Red
Rockaway Grey
Sapphire Blue



DOUBLE 4

WOODGRAIN

Matching Shake Colors: Pg 48
Matching Block Colors: Pg 51

Special Order Colors

Aviator Green
Caribou Brown
Eggplant
Lighthouse Red
Timber Bark
Yukon Grey

Item	Size	Pcs/Ctn
Sentry D4"	12' 6"	24 - 2 sq
5/8" J Channel	12'	40
3" Outside Corner	10'	12
Undersill Trim	12'	40
Inside Corner	10'	20
Aluminum Starter	10'	50

Performance Features

 COLOUR MATCHED ACCESSORIES	 ROLL-OVER NAIL HEM
 .044 THICK PREMIUM .044" THICKNESS	 LOW GLOSS LOW GLOSS COLOUR-RICH FINISH
 HURRICANE FORCE WIND SPEED RATED	 LIFETIME COLOUR FADE PROTECTION
 CONTOURED LOCK SYSTEM	 LIMITED LIFETIME WARRANTY

Special Order Profile



DOUBLE 4.5 DUTCHLAP

SIDING - PREMIUM COLORS

.045"

SENTRY BOARD & BATTEN

SIDING - TRADITIONAL COLORS

Stock Traditional Colors

- Bone
- Brownstone
- Flagstone
- Sandcastle
- Satin Grey
- White (Frost)

Special Order Traditional Colors

- Ash
- Cypress
- Hearthstone
- Indigo
- Nickel
- Saffron
- Sage
- Stratus



CEDAR GRAIN

Matching Shake Colors: Pg 48
 Matching Block Colors: Pg 51

Item	Size	Pcs/Ctn
Sentry B&B 7"	10'	17 - 1 sq
5/8" J Channel	12'	40
3" Outside Corner	10'	12
Undersill Trim	12'	40

Performance Features

- COLOUR MATCHED ACCESSORIES
- ROLL-OVER NAIL HEM
- .045 THICK PREMIUM .045 THICKNESS
- LOW GLOSS LOW GLOSS COLOUR-RICH FINISH
- HURRICANE FORCE WIND SPEED RATED
- LIFETIME COLOUR FADE PROTECTION
- CONTOURED LOCK SYSTEM
- LIMITED LIFETIME WARRANTY



SENTRY BOARD & BATTEN

.050"

Stock Premium Colors

Richmond Red

Special Order Premium Colors

Annapolis Blue

Aviator Green

Caribou Brown

Coffee Bean

Eggplant

Grenadier Green

Gunmetal Grey

Huron Blue

Khaki Brown

Lighthouse Red

Muskoka Green

Regatta Blue

Rockaway Grey

Sapphire Blue

Timber Bark

Yukon Grey



CEDAR GRAIN

Matching Shake Colors: Pg 48
Matching Block Colors: Pg 51

Item	Size	Pcs/Ctn
Sentry B&B Premium 7"	10'	17 - 1 sq
5/8" J Channel	12'	40
3" Outside Corner	10'	12
Undersill Trim	12'	40

Performance Features

COLOUR MATCHED ACCESSORIES	ROLL-OVER NAIL HEM
.050 THICK PREMIUM .050 THICKNESS	LOW GLOSS LOW GLOSS COLOUR-RICH FINISH
HURRICANE FORCE WIND SPEED RATED	LIFETIME COLOUR FADE PROTECTION
CONTOURED LOCK SYSTEM	LIMITED LIFETIME WARRANTY

SIDING - PREMIUM COLORS



.044"

SIDING - VARIEGATED COLORS

SENTRY VARIEGATED

RUSTIC COLORS

Special Order Colors



Arctic Grey



Burnt Sienna



Farmhouse



Hemlock



Item	Size	Pcs/Ctn
Sentry D4" Variegated	12' 6"	24- 2 sq
5/8" J Channel	12'	40
3" Outside Corner Post	10'	12
Inside Corner Post	10'	20
Undersill Trim	12'	40

Performance Features



NO FADE
PROMISE



PREMIUM
.044" THICKNESS



HURRICANE FORCE
WIND SPEED RATED



CONTOURED
LOCK SYSTEM



ROLL-OVER
NAIL HEM



LOW GLOSS
TWO TONE FINISH



LIMITED LIFETIME
WARRANTY

Special Order Profiles

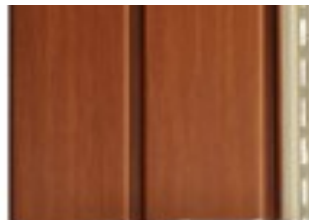

*D5 soffit (.040" thickness)
for soffit application and
D5 vertical siding
application.



DARK ROAST VINYL TRIM - MITTEN

SPECIAL ORDER

Perk up your exterior designs

When used in the right spots – like the exterior of a home – the minimalist aesthetic of dark vinyl trim boldly accents the details of a home and showcases its charm.

With Mitten's new vinyl trims in Dark Roast, you can easily achieve any contemporary style, including the modern farmhouse look that's as popular as ever.



Apex Outside Corner Post

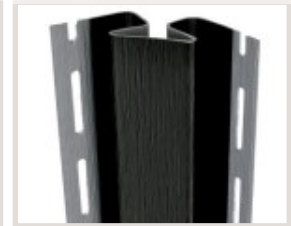

Inside Corner Post



J-Channel

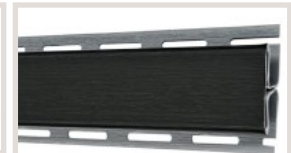

H-Trim

The perfect blend of features



Protection Against Heat

Made from reflective materials that prevent heat absorption and distortion.



Designed for Durability

The outer surface, colour pigments and substrate are molecularly bonded to form a rugged, long-lasting trim.



No-Fade Promise

A tough, UV-stable polymer resists chemical breakdown and reflects the sun's harmful rays.



Easy Maintenance

Never needs painting, caulking or patching. It won't peel, crack or rpt. Cleaning requires nothing more than soap and water.

FRESHLY BREWED

By pushing the boundaries of vinyl siding we have developed the darkest trims in the industry.

Item	Size	Pcs/Ctn
Apex Outside Corner Post	10'	12
Inside Corner Post	10'	20
5/8" J-Channel (1" face)	12'	40
H-Trim	12'	12



.046"

SIDING - PREMIUM COLORS

WEST RIDGE

SPECIAL ORDER



The **West Ridge Double 6"** panel captures the appearance of real wood siding with a wide modern profile. The double course panel offers a stunning 12" exposure that will serve as a statement piece in any exterior design project.



The luxury **Single 8"** plank has the timeless appearance of real wood with flat modern profile. Expertly designed with an impressively broad 8" single course width and a stack lock system, the West Ridge S8 plank offers a sleek, smooth and strong combination perfect for modern and contemporary designs.

- NO FADE PROMISE
- PREMIUM .046" THICKNESS
- HURRICANE FORCE WIND SPEED RATED
- D6-CONTOURED LOCK SYSTEM
- S8-STACK LOCK SYSTEM
- LOW GLOSS COLOR-RICH FINISH
- LIMITED LIFETIME WARRANTY

The ridged foam backing on both profiles provides added strength to an already thick .046" panel while still being lightweight and very easy to install.

Featuring 4 distinctive woodgrain finishes, 4 on trend solid colors and backed by a limited lifetime warranty, West Ridge is the pinnacle of vinyl siding designed to create luxury curb appeal.



WEST RIDGE D6" & S8"

.046"

Special Order Colors

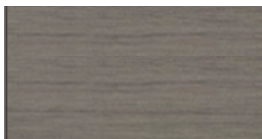

*Drift - Rustic

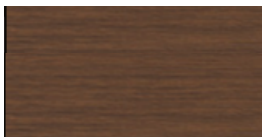

*Teak - Rustic

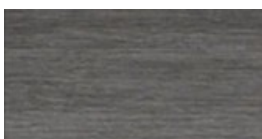

*Artic Grey - Rustic

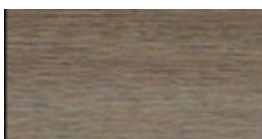

*Farmhouse - Rustic

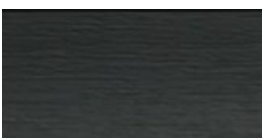

Gunmetal Grey - Bold

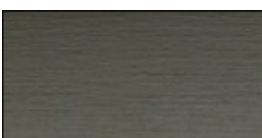

Rockaway Grey - Bold

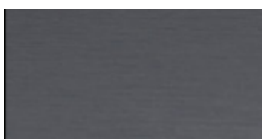

Huron Blue - Bold



Frost - Standard



Item	Size	Pcs/Ctn
West Ridge D6"	12' 6"	8 - 1 sq
West Ridge S8"	12' 6"	12 - 1 sq
7/8" J Channel	12'	32
7/8" Apex Outside Corner	10'	12
7/8" Inside Corner	10'	20
7/8" Undersill Trim	12'	28
Aluminum Starter Strip D6"	10'	50

Use color matched 7/8" J Channel for Starter Strip S8"



*Product will not fade in excess of a Delta E of 1 Hunter unit outside of the manufacturing tolerances in the first 5 years and a Delta E of 2 Hunter units outside of the manufacturing tolerances after the first 5 years from the date of the original installation of the product on the property.

SIDING - RUSTIC / BOLD / STANDARD COLORS

SOFFIT - MITTEN

Stock Solid & Full Vent T4" Colors

Black

Frost/White

Musket Brown - Full Vent Only
(Perforated)



Solid & Full Vent Soffit

Soffit not available in Premium Colors.

SOFFIT



Center Vent



7" Beaded

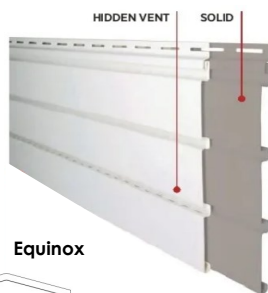

Equinox

Item	Size	Pcs/Ctn
T 4" Solid	12" x 12'	16 - 2 sq
T 4" Full Vent - Perforated	12" x 12'	16 - 2 sq
T 4" Full Vent - Weaved (white only)	12" x 12'	16 - 2 sq

Center Vent Soffit - White Only

Item	Size	Pcs/Ctn
T 4" Center Vent-Perforated & Weaved	12" x 12'	16 - 2 sq

Beaded 7" Soffit - White Only

Item	Size	Pcs/Ctn
7" Beaded Solid	7" x 12'	28 - 2 sq
7" Beaded Hidden Vent	7" x 12'	28 - 2 sq

Equinox Soffit - White Only

Item	Size	Pcs/Ctn
Equinox Solid Vent	10" x 12'	20 - 2 sq
Equinox Hidden Vent	10" x 12'	20 - 2 sq

- Triple 3-1/3 profile (10" wide)
- Premium .045" thickness for extra rigidity
- Deep 1/2" panel projection for sharp definition
- Net free air intake per foot: Vented 8.4 sq. in.



ACCESSORIES - MITTEN

Stock Colors

Frost/White

Premium Stock Colors

Black

Musket Brown

7/8" J Stock Colors

Annapolis Blue

Gunmetal Grey

Khaki Brown

Muskoka Green

Richmond Red

Rockaway Grey

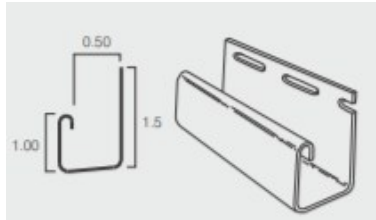

Item	Size	Colors	Pcs/Ctn
1/2" Soffit J	12'	Musket Brown, White, Black	50

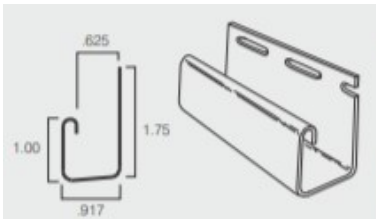

Item	Size	Color	Pcs/Ctn
5/8" J	12'	White, Some Colors	40

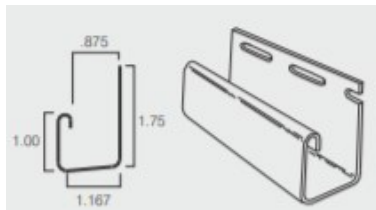

Item	Size	Color	Pcs/Ctn
7/8" J	12'	White, Some Colors	40

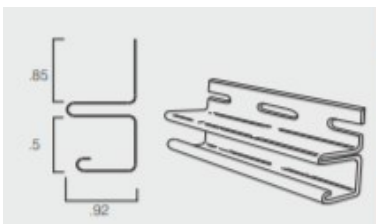

Item	Size	Color	Pcs/Ctn
1/2" F	12'	White, Colors	40

ACCESSORIES - TRADITIONAL & PREMIUM COLORS

.040"

FAIRWAY D4"

SIDING - TRADITIONAL COLORS

Stock D4" Colors

- Almond
- Classic Linen
- Clay
- Gray
- Khaki
- Prairie Wheat
- Sage
- Sand
- Sandstone
- Slate
- Slate Blue
- Tan
- White



DOUBLE 4

WOODGRAIN

Matching Shake Colors: Pg 49
 Matching Block Colors: Pg 51

Item	Size	Pcs/Ctn
Fairway D4" Siding	12' 6"	24 - 2 sq
5/8" J Channel	12' 6"	40
3" Outside Corner	10'	10
Undersill Trim	10'	50
Inside Corner	10'	10
Aluminum Starter	10'	50

Rollover Nail Hem



Weathered woodgrain appearance

.040" thickness

LineLock™ panel locking system

1/2" lap profile

Vapor Vent™ weep hole system

High-grade vinyl compounds and UV inhibitors

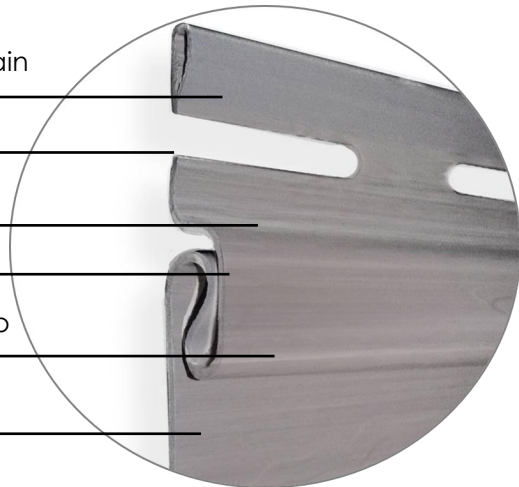

CEDAR CREEK D4"D & D5"

.040"

Stock D4"D & D5" Color

White

Special Order Colors

Almond

Antique Ivory

Classic Linen

Clay

Cobblestone

Gray

Heritage Gray

Khaki

Prairie Wheat

Sage

Sand

Sandstone

Slate

Slate Blue

Tan



DOUBLE 4
DUTCHLAP



DOUBLE 5

WOODGRAIN

Matching Shake Colors : Pg 49
Matching Block Colors: Pg 51

Item	Size	Pcs/Ctn
Cedar Creek D4"D	12' 6"	24 - 2 sq
Cedar Creek D5"	12'	20 - 2 sq
5/8" J Channel	12' 6"	40
3" Outside Corner	10'	10
Undersill Trim	10'	50
Inside Corner	10'	10
Aluminum Starter	10'	50



DOUBLE 5
DUTCHLAP

D5"D
Available
Special Order

Weathered woodgrain
appearance

.040" thickness

LineLock™ panel
locking system

1/2" lap profile

Vapor Vent™ weep
hole system

High-grade vinyl
compounds and
UV inhibitors

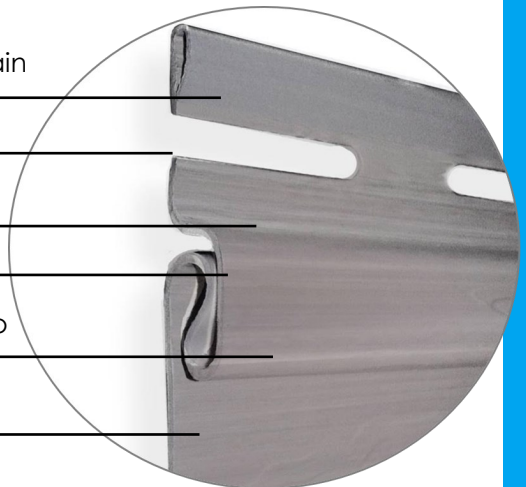

SIDING - TRADITIONAL COLORS

.042"

WATERFORD T3"

Stock T3" Colors

White

Special Order Colors

Antique Ivory

Classic Linen

Clay

Cobblestone

Gray

Heritage Gray

Khaki

Pine

Prairie Wheat

Sage

Sand

Sandstone

Slate

Slate Blue

Tan



TRIPLE 3

WOODGRAIN

Matching Shake Colors: Pg 49

Matching Block Colors: Pg 51

SIDING - TRADITIONAL COLORS

Item	Size	Pcs/Ctn
Waterford T3"	12' 1"	22 - 2 sq
5/8" J Channel	12' 6"	40
3" Outside Corner	10'	10
Undersill Trim	10'	50
Inside Corner	10'	10
Aluminum Starter	10'	50

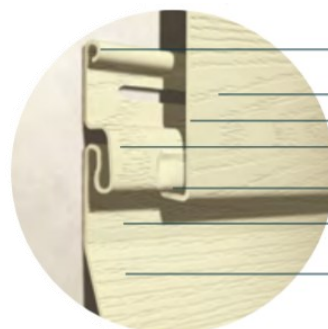

Rolled/reinforced nail hem

Realistic weathered pine texture

.042" thickness

LineLock™ panel locking system

1/2" lap profile

Vapor Vent™ weep hole system

UV inhibitors

Special Order Profiles



DOUBLE 4



DOUBLE 4 DUTCHLAP



DOUBLE 4.5 DUTCHLAP



DOUBLE 5 DUTCHLAP



DOUBLE 5

NORTHERN STAR BOARD & BATTEN

.046"

Special Order Traditional Colors



WOODGRAIN

Matching Shake Colors: Pg 49
Matching Block Colors: Pg 51



Special Order Premium Colors



Item	Size	Pcs/Ctn
Northern Star B&B	10'	17 - 1 sq
5/8" J Channel	12' 6"	40
3" Outside Corner	10'	10
Undersill Trim	10'	50



KP's Ultra-Vinyl UV technology compounds combat the harsh rays of the sun.

Low-gloss, rough cedar texture for a look of real wood.

Thickness of .046" for outstanding impact resistance and strength.

Full 1/2" profile for dramatic shadow lines.

Full 7" exposure with 5 1/2" face and 1 1/2" batten.

SIDING - TRADITIONAL & PREMIUM COLORS

.044"

SIDING - PREMIUM COLORS - VARIEGATED

HARBOR RIDGE RUSTIC

Special Order Colors

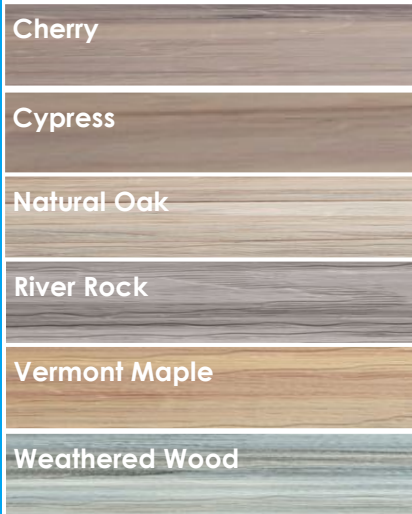

DOUBLE 4

VARIEGATED WOODGRAIN



DOUBLE 5 DUTCHLAP

D5''D
Available
Special Order

Item	Size	Pcs/Ctn
Harbor Ridge RUSTIC D4''	12' 6"	24 - 2 sq
5/8" J Channel	12' 6"	40
3" Outside Corner	10'	10
Undersill Trim	10'	50
Inside Corner	10'	10
Aluminum Starter	10'	50



FOUNDRY 6'' ROUND SHAPE

Stock Color

White



Starter



Item	Size	Pcs/Ctn
Round Shape - 6'' Exposure	60"	20-1/2 sq
7/8" J Channel	12'	40
Starter	60"	20



PLEASANT VIEW SKIRTING

Stock Color

White (ONLY)

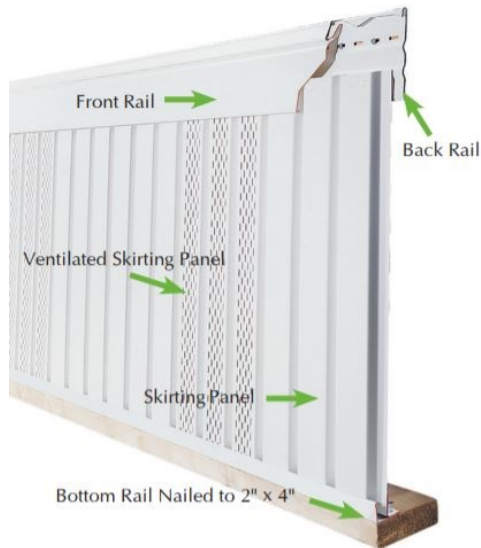

Item	Size	Pcs/Ctn
Solid Skirting	12" x 12'	16
Vented Skirting	12" x 12'	14
Skirt Trim Front	12'	16
Skirt Trim Back	12'	16
Bottom Rail	12'	16



.044"

SINGLE 8" WOODGRAIN

Stock 8" Color

White (ONLY)



Item	Size	Pcs/Ctn
Single 8" Siding	12' 6"	24 - 2 sq
5/8" J Channel	12'	40
3" Outside Corner	10'	10
3/4" Inside Corner	10'	20
Undersill Trim	12'	40
Aluminum Starter	10'	50



SOFFIT - ABTCO

Special Order Colors

Almond
Classic Linen
Clay
Gray
Khaki
Prairie Wheat
Sage
Sand
Sandstone
Slate
Slate Blue
Tan
White



Solid & Full Vent Lanced Soffit - Brushed

Item	Size	Pcs/Ctn
T 4" Solid	12" x 12'	16 - 2 sq
T 4" Full Vent Lanced	12" x 12'	16 - 2 sq

Beaded Soffit - Brushed

Stock Beaded 8"

White (ONLY)



8" Beaded Solid



8" Beaded Invisible Vent

Item	Size	Pcs/Ctn
8" Beaded Solid	8" x 12'6"	12 - 1 sq
8" Beaded Invisible Vent	8" x 12'6"	12 - 1 sq

ACCESSORIES - ABTCO

Stock Colors

Almond
Classic Linen
Clay
Gray
Khaki
Prairie Wheat
Sage
Sand
Sandstone
Slate
Slate Blue
Tan
White



Soffit J



F Channel

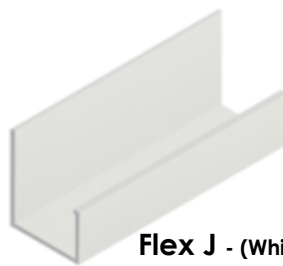

Flex J - (White only)



H Channel - (White only)

Item	Size	Color	Pcs/Ctn
5/8" Soffit J	12' 6"	White	40
5/8" Soffit J	12' 6"	Colors	40
5/8" Flex J	12'	White Only	12
1/2" F	12' 6"	White	40
5/8" H	12' 6"	White Only	24

ACCESSORIES - TRADITIONAL COLORS

METALUNIC - MODERNO

www.metalunic.com

Call for Inventory Availability

ARCHITECTURAL STEEL SIDING

Cedarwood

Desert

Espresso

Moonlight Grey

Smoked Black

Urban Grey



AUTHENTIC WOOD LOOK

Full line of matching accessories below. Panels and accessories sold by the box. No Returns.

SIDING - ARCHITECTURAL STEEL



J Molding



J Molding 2



Starter



Drip Edge

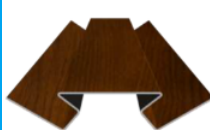

Inside Corner



Outside Corner

Item	Size	Pcs/Ctn
Moderno Standard Panel	5.65"W x 12'L	12pcs / 67.5sq ft
5/8" J Molding	10'	10
5/8" J Molding 2 Part	10'	10
3" Outside Corner	10'	4
Inside Corner	10'	4
Drip Edge	10'	10
Galvanized Steel Starter	10'	30
Wood Screws	1 1/8"	
Steel Coil	16" x 50'	26 GA
Touch-up Paint	5oz	
Hand Guillotine		

STANDARD MODERNO

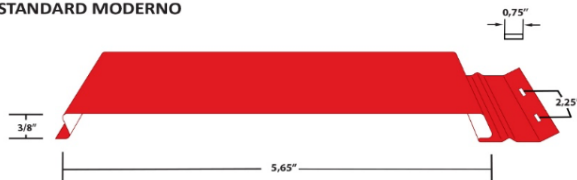

VENTED MODERNO SOFFIT

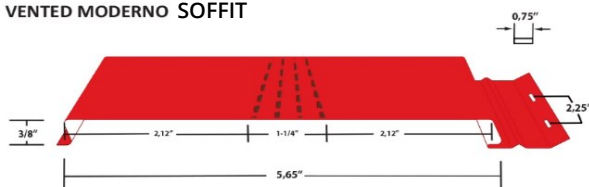

ALIGN COMPOSITE CLADDING

www.gentekinc.com

Special Order Colors

Almond
Dover Gray
Monterey Sand
Pebble
Snow White
Iron Ore
Majestic Brick
Marine Dusk
Windswept Smoke
Chesapeake Gray
Coastal Blue
Dark Drift
Harbor Bay
Hudson Slate
Meadow Fern
Midnight Surf
Moonlit Moss
Rockport Brown
Smoked Timber
Storm



REALISTIC WOOD TEXTURE WITH HEIGHTENED STRUCTURAL STRENGTH

Item	Size	Pcs/Ctn
7" ALIGN Composite Plank	12' 3"	14 - 1sq
2 1/2" Universal Steel Starter Strip	10'	24
Finish Trim - White Only	12' 6"	20
3 1/2" Outside Corner Post	10'	10
Inside Corner Post	10'	10
3/4" J-Channel	12'	40
2 1/2" Wide Face J-Channel - White Only	12'	18



SIDING - TRADITIONAL & PREMIUM COLORS

NOTES



EVOLVE
STONE

www.evolvestone.com

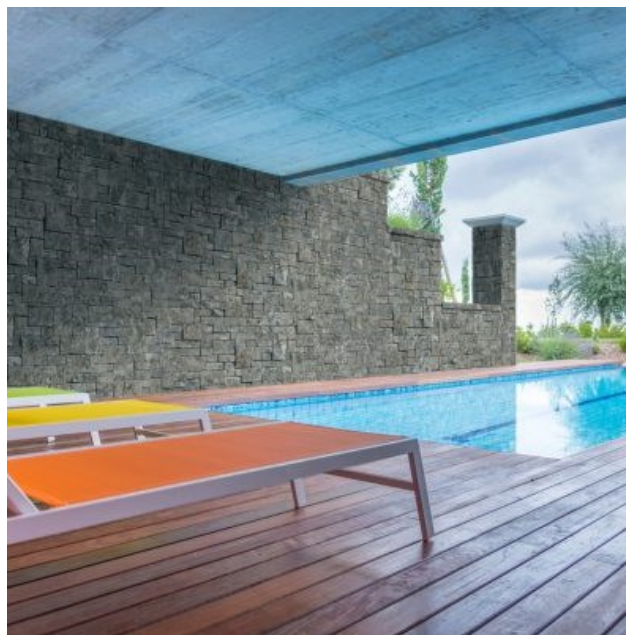

STONE



STONE



Most realistic stone veneer product on the market

10x faster installation

Moisture impermeable

Extremely durable

No heavy-duty staging or scaffolding

No lath, mortar, or hardware required



*Monument Gate and National True Styles Only



MUST PURCHASE FULL BOXES - NO RETURNS

Item	Size	Pcs/Ctn
Evolve Stone	14.25sq ft/box	7 boxes (1 sq approx)
Corner (Special Order)	Varies	7 lin. ft / box
Rainscreen 1/8"	4' x 50'	200 sq ft/roll
Sill	2" x 2.5" x 20"	25 lin. ft/15pcs
TremGrip Adhesive	10 oz	12
Vulkem Primer Masonry Application	1qt	-
Typar Housewrap	3' x 100'	Evolve Stone Warranty: Typar Housewrap only



EVOLVE STONE



Color: Phantom Shadow

GEORGETOWN RUN

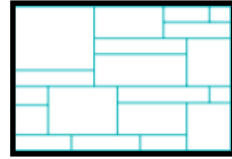

Stone Dimensions

Smallest Size:
Approx. 1 3/4" x 5"
Largest Size: Approx.
7" x 10"

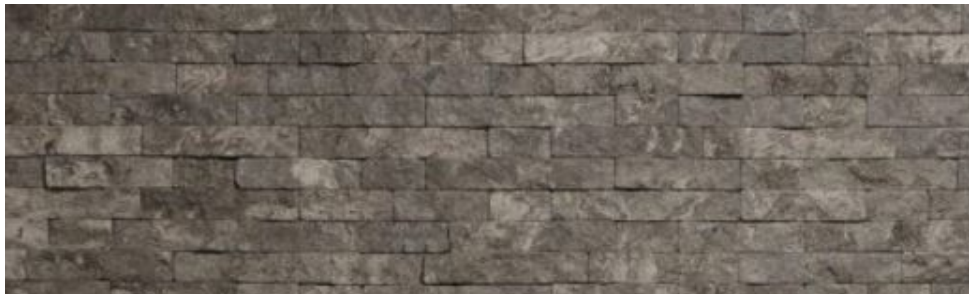

Color: Morning Aspen

DISTRICT VIEW

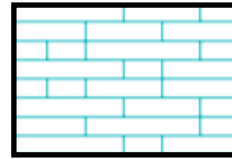

Stone Dimensions

Smallest Size:
Approx. 2" x 4"
Largest Size: Approx.
2" x 11 1/2"



Color: Dune Point

NATIONAL TRUE

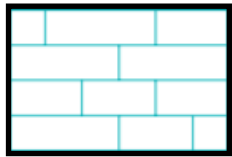

Stone Dimensions

Smallest Size:
Approx. 4" x 7 3/4"
Largest Size: Approx.
4" x 15 1/2"



Color: Kodiak Mine

CAPITAL SKY

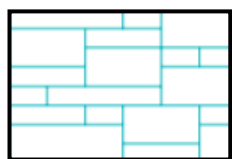

Stone Dimensions

Smallest Size:
Approx. 2" x 4"
Largest Size: Approx.
4" x 15 1/2"



Color: Winter Valley

MONUMENT GATE

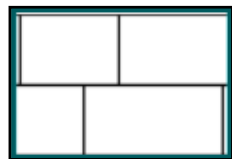

Stone Dimensions

Smallest Size:
Approx. 8" x 12"
Largest Size: Approx.
8" x 20"

STONE

DURAKWIK STONE

www.durakwikstone.com



- Lightweight - Approx 11lb/ft²
- Easy to install - no mortar, installs with screws
- Realistic appearance - molded off real stones
- Interlocking edges
- Resistance to UV/discoloration, moisture, and extreme temp variation
- Resistance to salt water corrosion and wind
- R-value = 4.3/in of thickness

Corners



Ledge Stone

Arizona Trail | Rocky Boulder
Taylors Falls | Volcano Ash



Stacked Stone

Arizona Trail | Sierra Nevada
Volcano Ash | Yosemite Hike



Slatestone Contemporary

Coal Mine

Accessories



Ledger

Gray | Black



Trim

Gray | Black

MUST PURCHASE FULL BOXES - NO RETURNS

Item	Size	Pcs/Ctn
Ledge Stone Corner	13"H x 4" x 10"	4/box (4lin ft)
Stacked Stone Corner	13"H x 4" x 10"	4/box (4lin ft)
Slatestone Contemporary Corner	13"H x 4" x 10"	4/box (4lin ft)
Ledger/Sill	48"L x 4"H x 2"W	4/box (16lin ft)
Trim	48"L x 4"H x 2"W	4/box (16lin ft)

DURAKWIK STONE

LEDGESTONE

48" W x 13" H x 2" T

4 pcs per box (15.6 sq ft)



308 Panel - Arizona Trail



308 Panel - Rocky Boulder



308 Panel - Taylors Falls



308 Panel - Volcano Ash

STACKED STONE

48" W x 13" H x 2" T

4 pcs per box (15.6 sq ft)



310 Panel - Arizona Trail



310 Panel - Sierra Nevada



310 Panel - Volcano Ash



310 Panel - Yosemite Hike

SLATESTONE CONTEMPORARY

48" W x 13" H x 1.5" T

4 pcs per box (15.6 sq ft)



301 Panel - Coal Mine

MUST PURCHASE FULL BOXES - **NO RETURNS**

.085"

FAIRHAVEN SOUND



SHAKE - TRADITIONAL COLORS

Stock 7" Colors

- Canyon Clay
- Dover Gray
- Linen
- Maize
- Monterey Sand
- Pearl
- Pebble
- Sage
- Snow White
- Wicker

Special Order 7" Colors

- Almond
- Juniper Grove
- Sandstone



SINGLE COURSE TRADITIONAL SHAKE

Matching Siding Colors:
Pages 6,8,10

Item	Size	Pcs/Ctn
7" Single Shake	6'9"	13 - 1/2 sq
Traditional Shake Corner	15.86"	10
10' Vinyl Corner	3.5" x 10'	10
3/4" J Channel	3/4" x 12'	40
Starter Strip	10'	25

Traditional Shake Corner

15.86"
Natural Cedar Texture

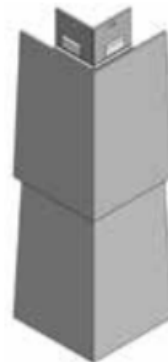
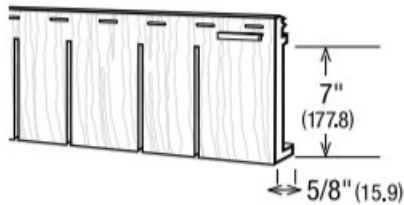



FAIRHAVEN SOUND

.085"

Stock 7" Colors

- Chesapeake Gray
- Coastal Blue
- Dark Drift
- Espresso
- Harbor Bay
- Hudson Slate
- Iron Ore
- Majestic Brick
- Marine Dusk
- Meadow Fern
- Midnight Surf
- Moonlit Moss
- Storm
- Windswept Smoke

Special Order 7" Colors

- Rockport Brown
- Smoked Timber



SINGLE COURSE TRADITIONAL SHAKE

Matching Siding Colors:
Pages 7,9,11

Item	Size	Pcs/Ctn
7" Single Shake	6'9"	13 - 1/2 sq
Traditional Shake Corner	15.86"	10
10' Vinyl Corner	3.5" x 10'	10
3/4" J Channel	3/4" x 12'	40
Starter Strip	10'	25

Traditional Shake Corner

15.86"
Natural Cedar Texture

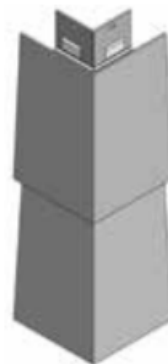
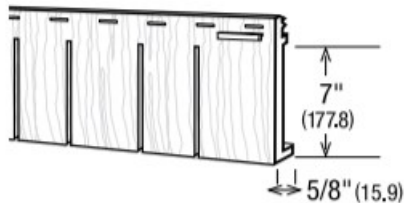

SHAKE - PREMIUM COLORS

.075"

CAPE COD SHINGLE

SHINGLE - TRADITIONAL & PREMIUM COLORS

Special Order Traditional D5" Colors

- Almond
- Dover Gray
- Linen
- Maize
- Monterey Sand
- Pearl
- Sandstone
- Canyon Clay
- Juniper Grove
- Pebble
- Sage
- Snow White
- Wicker

Special Order Premium D5" Colors

- Chesapeake Gray
- Coastal Blue
- Dark Drift
- Espresso
- Harbor Bay
- Hudson Slate
- Iron Ore
- Majestic Brick
- Marine Dusk
- Meadow Fern
- Midnight Surf
- Moonlit Moss
- Rockport Brown
- Smoked Timber
- Storm
- Windswept Smoke



DOUBLE 5"

Matching Siding Colors Available:
Pages 6,7,8,9,10,11

Item	Size	Pcs/Ctn
D5" Cape Cod Shingle	5'5"	11 - 0.5sq
10' Vinyl Corner	3.5" x 10'	10
3/4" J Channel	3/4" x 12'	40
Starter Strip	10'	25

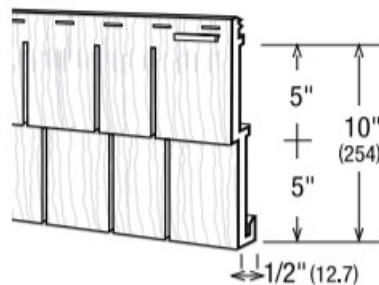

GRAYNE 5" & 7.5" CEDAR SHINGLE

Call for profile and color availability - many in stock

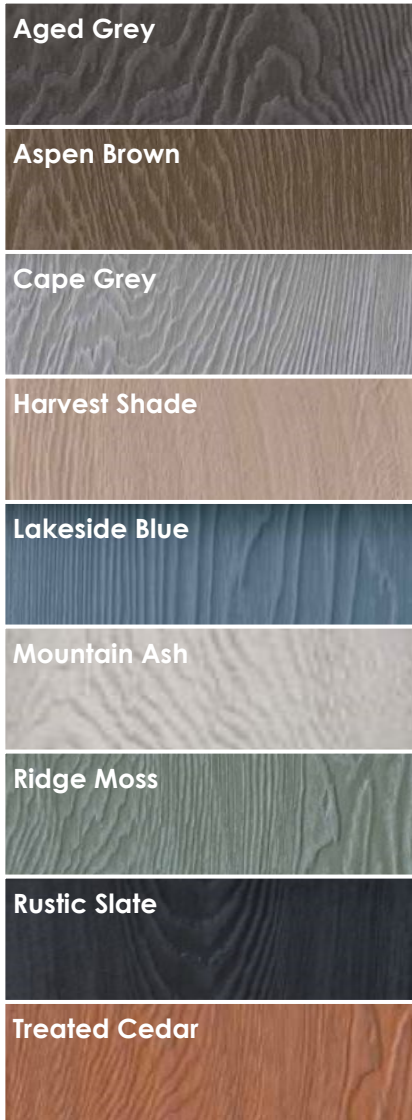

Treated Cedar

Item	Size	Pcs/Ctn
5" Exposure	60 1/2"	24 - 1/2sq
7.5" Exposure	60 1/2"	32 - 1sq
3/4" J Channel	3/4" x 7'5"	20
Undersill	7'5"	20
Aluminum Starter	10'	50

Gorgeously replicates the look of cedar. Features a realistic woodgrain you have to see to appreciate.

- Wind resistance up to 170 mph
- Class A fire rated
- Easy to install design
- Single course panels save waste
- Never needs painting or staining
- Limited lifetime warranty
- Made in USA
- Won't warp, sag, or buckle



Aged Gray

<https://FoundrySiding.com/Grayne-shingle/>



FOUNDRY 7" PERFECTION SHINGLE

Stock Traditional 7" Colors

#263 Brownstone
#589 Cypress
#580 Flagstone
#501 Hearthstone
#700 Sage
#613 Satin Grey
#123 Snow (Frost)
#258 Stratus

Stock Premium 7" Colors

#572 Annapolis Blue
#695 Gunmetal Grey
#610 Khaki Brown
#573 Muskoka Green
#577 Richmond Red
#528 Rockaway Grey

Stock Weathered 7" Colors

#822 Harvest Wheat
#834 Red Cedar



SINGLE COURSE SHINGLE

Matching Siding Colors: Pages 16,17,18,19, 20, 21

Item	Size	Pcs/Ctn
7" Solid	60.75"	34 - 1 sq
7" Weathered	60.75"	34 - 1 sq
7/8" J Channel	12'	40
7/8" J Premium Color	12'	40
Vinyl Corner	10'	12
Vinyl Corner - Premium Color	10'	12
7" Corner Kit*	56"	-
Aluminum Starter	10'	50

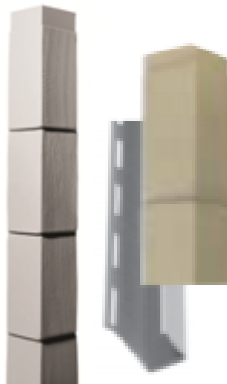

*Vinyl Corner Kit (special order)

Kit includes:

- 4 Corners
- 8 Pieces of 3/4" J Channel
- 18.7 Lineal Ft.

MORE THAN 250 DISTINCTIVE COLORS AVAILABLE



PERFECTION SHINGLES 7"

-.090"

Special Order 7" Traditional

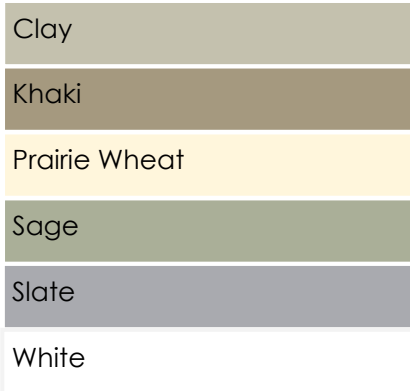

Special Order 7" Colors



7" SINGLE COURSE

Matching Siding Colors: Pages 28,29,30

7" Dual Course also available via special order.

Item	Size	Pcs/Ctn
7" Perfection	71.75"	14 - 1/2 sq
5/8" J Channel	12' 6"	40
Vinyl Corner	10'	10
Perfection Corner (all colors special order)	28"	5
Perfection Starter Strip (special order) (can use generic starter)	10'	25



SHINGLE - TRADITIONAL & PREMIUM COLORS

Special Order 7" Premium Rustic Colors



BLOCKS & VENTS

ACCESSORIES

<p>Mountmaster Level & waterproof surface.</p>	<p>Surface Block For install after siding is up.</p>	<p>Exhaust Vent 12 sq inch net free area.</p>	<p>4" Hooded Vent 12 sq in net free area.</p>
<p>Mini Block</p> <p>For door bells, switches, outlets, etc.</p>	<p>Split Block Mini</p> <p>Fits around existing pipes and wires.</p>	<p>Intake/Exhaust Vent</p> <p>Full fiberglass screen. Not for dryers/furnace.</p>	<p>Electrical Box</p> <p>UL LISTED</p>
<p>Foundation Vent Molded in screen. 50 sq inch net free area.</p>		<p>Meter Block For meter and extra large fixtures.</p>	<p>Jumbo For larger coach lamps.</p>

Blocks	Colors	Pcs/ Ctn	Vents	Size	Colors
Exhaust Vent-Square	All	4	Square	12" x 12"	All
Split Block Mini	All	10	Rectangle	12" x 18"	All
Jumbo Block	All	10	Rectangle	18" x 24"	White
Mountmaster-Square	All	10	Round	18"	White
4" Hooded Vent	White	1	Octagon	18"	White
Mini Block	White	10	Half Round	34" x 22"	White
Surface Block	White	10	Round Top	14" x 22"	White
Intake/Exhaust	White	1			
Electrical Box	White	2			
Foundation Vent	White	10			
Meter Block	White	1			



BLOCK & VENT COLORS

ALL COLORS ARE BEST MATCH

Mitten Stock Traditional

Bone
Brownstone
Flagstone
Frost
Hearthstone
Indigo
Nickel
Saffron
Sage
Sandcastle
Satin Gray
Stratus

Gentek Stock Traditional

Canyon Clay
Dover Gray
Linen
Maize
Monterey Sand
Pearl
Pebble/Hickory
Sage
Snow
Wicker

ABTCO Stock Traditional

Almond
Classic Linen
Clay
Gray
Khaki
Prairie Wheat
Sage
Sand
Sandstone
Slate
Slate Blue
Tan
White

Mitten Stock Premium

Annapolis Blue
Aviator Green
Caribou Brown
Coffee Bean
Eggplant
Grenadier Green
Gunmetal Gray
Khaki Brown
Muskoka Green
Regatta Blue
Richmond Red
Rockaway Grey
Sapphire Blue

Gentek Stock Premium

Chesapeake Gray
Coastal Blue
Dark Drift
Espresso
Harbor Bay
Hudson Slate
Iron Ore
Majestic Brick
Marine Dusk
Meadow Fern
Midnight Surf
Moonlit Moss
Storm
Windswept Smoke

ABTCO Stock Premium

Cabot Blue
Cabot Brown
Cabot Red
Castlemoore
Manor



Mountmaster



Split Mini Block

ACCESSORIES

SHUTTERS

Stock Colors

002 - Black
027 - Burgundy Red
036 - Classic Blue
028 - Forest Green
166 - Midnight Blue
010 - Musket Brown
018 - Tuxedo Grey
001 - White
078 - Wineberry



Special Order Colors

008 - Clay
385 - French Roast
030 - Paintable
945 - Platinum
419 - Storm Cloud
471 - Treated Cedar



**Open Louvered
14.5" Width**

**Raised Panel
14.75" Width**

	<u>Length</u>		<u>Length</u>
	25"		31"
	31"		35"
	36"		39"
	39"		43"
	43"		47"
	48"		51"
	52"		55"
	55"		59"
	57"		63"
	60"		67"
	64"		71"
	67"		75"
72"	80"		
75"			
80"			

- Shutters are priced and packed by the pair (2).
- All stock shutters are packed with both plastic push pins and screws.
- 12" wide and other custom shutter sizes are available: Call for pricing and details.
- Special order colors available in above sizes. Call for pricing and details.

20' VINYL CORNERS

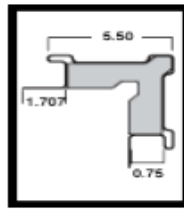

TRADITIONAL

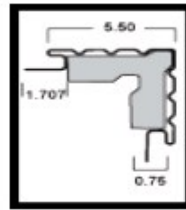

FLUTED

Stock Color: White



Item	Size	Pcs/Ctn
Traditional Corner	20'	5
Fluted Corner	20'	5

Both styles have a foam insert included.

ACCESSORIES

WINDOW CASING



Pebble finish

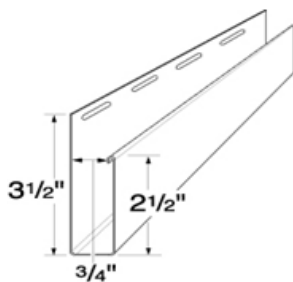

Stock Color: White

Size	Pcs/Ctn
12' 6"	20

WINDOW & DOOR HEADERS



6" Classic Dentil

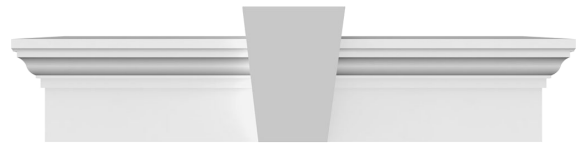

6" Flat Panel

Flat Panel and Dentil Headers - 6" Height Stock Color: White

Flat Panel or Dentil Size	Top Width	Bottom Width
33-5/8"	36-1/2"	33-5/8"
37-5/8"	40-1/2"	37-5/8"
43-5/8"	46-1/2"	43-5/8"
65-5/8"	68-1/2"	65-5/8"
73-5/8"	76-1/2"	73-5/8"

*Door Size Reference Chart

Door Size	Header Width
32"	51-1/2"
36"	55-1/2"
10'	139-1/2"
16'	211-1/2"

Keystone shipped with header for optional application.



9" Garage Door Header (Flat Panel Only)

Size	Top Width	Bottom Width
128"	132-1/4"	128"

See Mid America catalog for Special Order Colors.

WINDOW & DOOR LINEALS

Stock Color: White

Item	Size	Pcs/Ctn
3.5" Lineal	20'	10
5" Lineal	20'	10
Starter	12' 6"	40
Quarter Round	20'	5



3.5" Lineal



5" Lineal

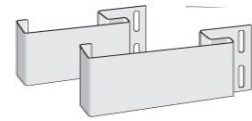

Lineal Side View



Starter

BAY WINDOW CORNERS 45°

Stock Color: White

Item	Size	Pcs/Ctn
Outside Corner	10'	20
Inside Corner	10"	20



Outside



Inside



ACCESSORIES

DOOR SURROUND SET



Door Pilaster Set: White Only

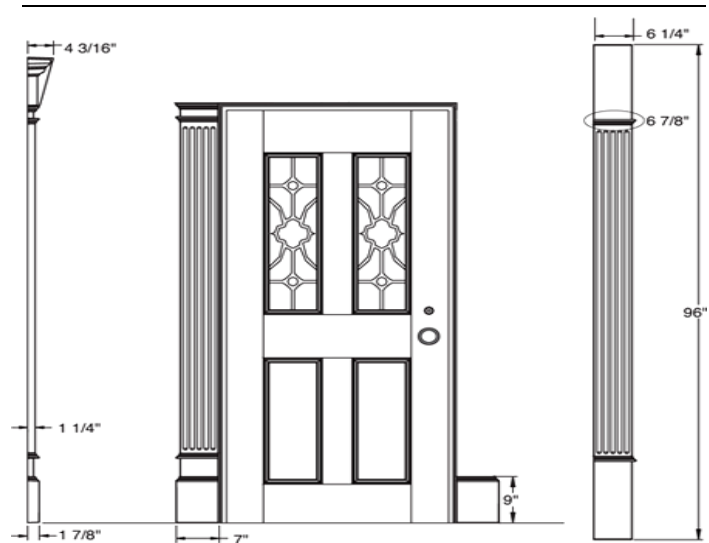

Each Door Pilaster Set Includes:



- 2 Pilasters with bases
- 2 Bottom corners with Bases
- 2 Transition tops
- 4 Transition clips and fasteners

To order optional header, see Door Size Reference Chart* on opposite page.
Door Pilaster Set can be applied before or after siding.

ACCESSORIES

PVC Post Wraps BY KLEER

Post Wrap Set - 1 Outer Wrap, 1 Top & Bottom Bed Moulding

Size	Inside	Outside		
4"x4"x8'	3.75"x3.75"	4.5"x4.5"		
4"x4"x10'	3.75"x3.75"	4.5"x4.5"		
6"x6"x8'	5.75"x5.75"	6.5"x6.5"		
6"x6"x10'	5.75"x5.75"	6.5"x6.5"		

Outer Wrap

Top & Bottom Bed Moulding

Post Wrap Accessories - Packed one per box

Item	Size	Item	Size
Bed Moulding Pair	4"x4"	Bed Moulding for Outer Wrap	6"x6"
Bed Moulding Pair	6"x6"	Outer Wrap for 4x4 Post	5"
Crown	4"x4"	Outer Wrap for 4x4 Post	7"
Crown	6"x6"	Outer Wrap for 4x4 Post	12"
Base Cap for Outer Wrap	4"x4"	Outer Wrap for 6x6 Post	5"
Base Cap for Outer Wrap	6"x6"	Outer Wrap for 6x6 Post	7"
Bed Moulding for Outer Wrap	4"x4"	Outer Wrap for 6x6 Post	12"



Bed Moulding for Outer Wrap



Crown

PVC ACCESSORIES BY KLEER

Other Accessories

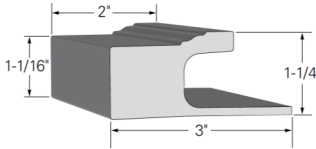
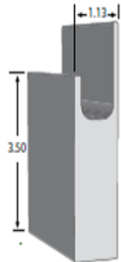
Item	Size	Unit		
3.5" Window Casing	16'	4		
J Channel Brickmould	17'	6		
Hidden Trim Fasteners		1		



Hidden Trim Fasteners includes:

- 375 - 2-3/4" Screws
- 400 Plugs
- Setting Tool

Coverage: 250 lineal feet



INSULATION



Item	Pack	Facer	R-Value
*3/8" Fanfold	2 sq	Foil/Kraft	1.46
3/8" Fanfold	2 sq	Foil / Foil	1.50
3/4" Fanfold	1 sq	Foil / Foil	3.0
3/8" Fanfold Greenguard	2 sq	Perforated	1.50
1/2" Shiplap	1 sq	Perforated	3.0
3/4" Shiplap	1 sq	Perforated	3.8

*Custom name imprint - 8 pallet minimum
Initial plate fee - \$500

Polar puts over 1,000 vapor holes in every square foot of WeatherAll. These tiny holes enhance water vapor permeability. This important feature helps ensure the water vapor can escape the wall cavity, so as not to cause mold formation and structural damage.

HOUSEWRAP

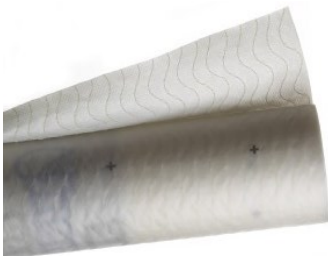

Item	Size
Housewrap	9' x 100'
Typar Housewrap	3' x 100'
Tape	1-7/8" x 55 yards
Housewrap with your logo	9' x 100'

Special order - no setup charge. 30 roll Increments

ALUMINUM COIL

ALL COLORS ARE BEST MATCH

Mitten Stock Traditional

Bone
Brownstone
Cypress
Flagstone
Frost
Sandcastle
Satin Gray
Stratus

ABTCO Stock Traditional

Almond
Classic Linen
Clay
Khaki
Prairie Wheat
Sage
Sand
Sandstone
Slate
Tan
White

Gentek Stock Traditional

Canyon Clay
Dover Gray
Linen
Maize
Monterey Sand
Pearl
Pebble/Hickory
Sage
Snow
Wicker

Mitten Stock Premium

Annapolis Blue
Gunmetal Gray
Muskoka Green
Richmond Red
Rockaway Grey

ABTCO Stock Premium

Cabot Blue
Cabot Brown
Cabot Red
Castlemoore
Manor

Gentek Stock Premium

Chesapeake Gray
Coastal Blue
Dark Drift
Espresso
Harbor Bay
Hudson Slate
Iron Ore
Majestic Brick
Marine Dusk
Meadow Fern
Midnight Surf
Moonlit Moss
Storm
Windswept Smoke

PVC Coil Color

White

Specialty Colors

Black
Musket Brown
Bronze
Grecian Green



Style	Size	Ga.	Colors
Smooth	24" x 50'	0.019	Yes
PVC	24" x 50'	0.019	White Only
G8 Polyester Finish	24" x 50'	0.019	Bright White

ACCESSORIES

NAILS



Item	Size	Pack	Packs/ Ctn	Colors
Stainless Trim	1-1/4"	1lb	25	Yes (to match coil stock colors)
Aluminum Siding	1-1/2", 1-3/4", 2", 2-1/2"	1lb	50	Mill
Galvanized Siding	1-1/2", 1-3/4", 2", 2-1/2"	50lb	1 Box	Mill

VINYL FASCIA

Stock Color: White



Size	Pcs/Ctn
8" x 12'	10

BRUSHED FINISH



CAULK



Size	Color	Pcs/Ctn
10oz	Clear	12
10oz	White	12

Colored caulk not available

BRAKES

SPECIAL ORDER ITEMS



PRO 14 and PRO 19 - 10' 6" length

Produces high-quality custom pieces for any siding and roofing application, from soffit and fascia to custom brickmold, sill trim, window casing, chimney flashing & more.

- PRO 14 has 14" throat depth
- PRO 19 has 19" throat depth

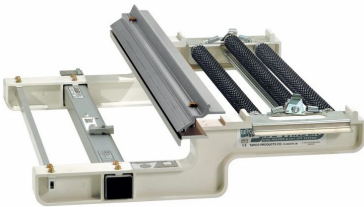

PRO Side Winder

Secures coil right onto your Tapco Tools brake system and feeds directly into the jaws of your brake, resulting in greater efficiency and no more windblown, dirty, damaged coils.



PRO Cut-Off

Provide single-pass cutting precision right on your brake.

- Factory-quality cuts
- Ergonomic grip for smooth, sure-handed operation



PRO Brake Buddy

Produces brickmold trim and decorative ribs from trim coil .



Snap Stand

Snap Stand legs offer sturdy, solid support for your PRO 14 and PRO 19 Brake.



Wheel Kit

Optional wheel kit for Snap Stand.



Port-O-Brake - 10'6" length

Lightweight and durable brake for producing high quality custom pieces.

- Optional legs available special order

TOOLS



Aluminum Snips - 12" & 14"



Nail Hole Punch



J-Channel Cutter



Seamer - 3" & 6"



Trim Nail Driver



Snap Lock Punch



Work. Perform. Outlast.



Zip Tool

fairway

Contact us to learn more about our displays and marketing collateral that can be customized with your logo.

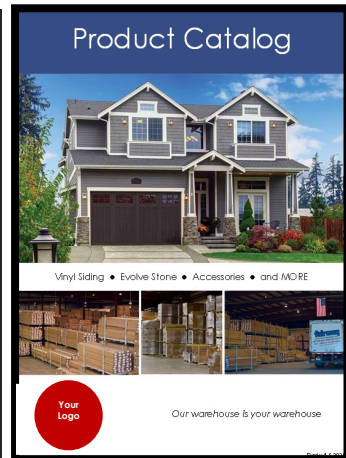

Company Name: _____
 Contact Name: _____
 Address: _____
 Phone: _____
 Fax: _____
 Email: _____

BIODIG ESTIMATION FORM

ITEMS	QUANTITY	UNIT PRICE	TOTAL	DATE
1. VINYL SIDING				
2. EVOLVE STONE				
3. ACCESSORIES				
4. MORE				

EVOLVE STONE

INTRODUCING EVOLVE STONE

The only mortars, color throughout, moisture permeable stone veneer that installs up to 10X faster and is a fraction of the weight compared to the competition. It looks and feels like real stone and installs with the ease of a fresh-water on wood sheathing or adhesive on existing masonry applications. This is the future of mortars-less stone veneer. This is Evolve Stone.

Evolve Stone is the creation of Evolve Manufacturing, whose clients include Cabell's, Sea World, Royal Caribbean, and the Disney Channel, among many others. Their innovative, unconventional approach, cutting edge technology, and decades of precision craftsmanship have made them the premier designer of rock structure environments in the world.

What's In It For You?

- Quick and Easy to Install
- No weather or temperature related installation restrictions
- Use for Exterior and Interior Projects
- Increase Curb Appeal and Market Value
- Unmatched Customization
- No specialized training or tools needed

Your business contact information here

[CLICK HERE TO VIEW GREAT VIDEOS AND SEE PHOTOS](#)

Contact us for great deals from the Fairway Wholesale Outlet

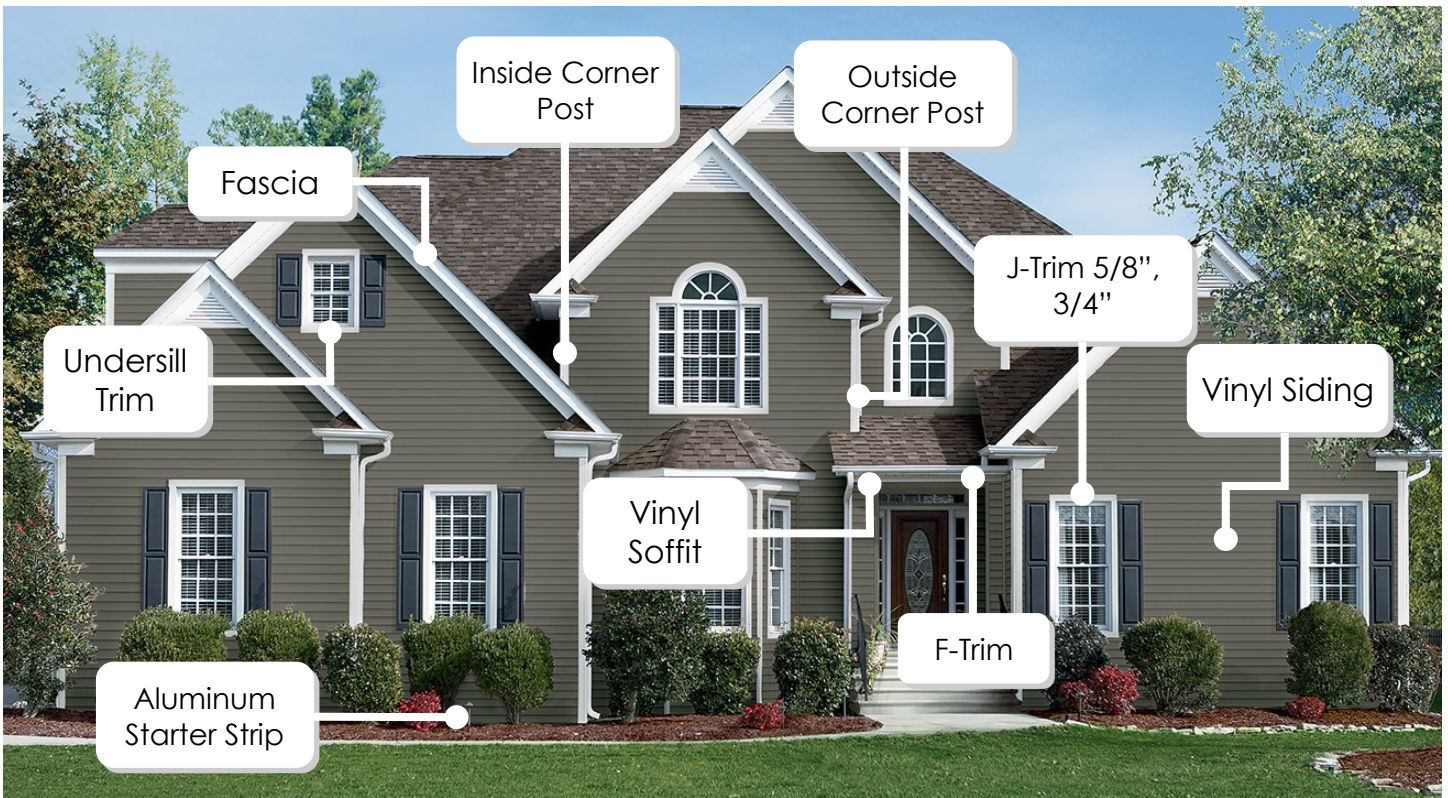

Step 1: Sketch Your Home

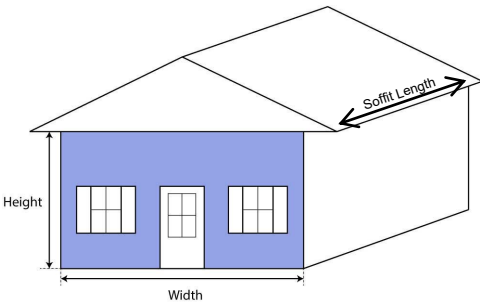

Create a sketch of your house with all four sides from the outside. Then determine the surface area of each wall by multiplying the height at the corner by the width of the wall.

Step 2: Misc. Measurements

Measure areas like gables, dormers, and any other sections not covered in your previous wall measurements. For triangular areas, calculate the area by multiplying the height from the base to the top by 1/2 the length of the base, then add up the areas of the gables and dormers.

Step 3: Windows & Doors

Measure the dimensions of windows, doors, and any other sections where siding will **not** be installed. Calculate the area of each by multiplying their width by height, and then sum up the totals.

Step 4: Calculate

Add up the areas calculated in steps 1 and 2. Then, subtract the total area calculated in step 3. Always include a 10% buffer for waste.

$$\text{Siding Required} = [\text{Step 1} + \text{Step 2} - \text{Step 3}] + 10\%$$

Step 5: Square of Siding

Each square of siding covers 100 square feet of wall area. To find out how much siding is needed, divide the total from step 4 by 100.

Step 6: Eaves

Measure underneath eaves and multiply the length by the width of each overhang and add them together.

Step 7: Soffit Calculation

Find the number of squares of soffits needed by dividing the total area from step 6 by 100.

Step 8: Accessories

Determine the number of linear feet of accessory items needed.

